

TRANSFORMER PROTECTION PANEL DOOR (REAR VIEW)

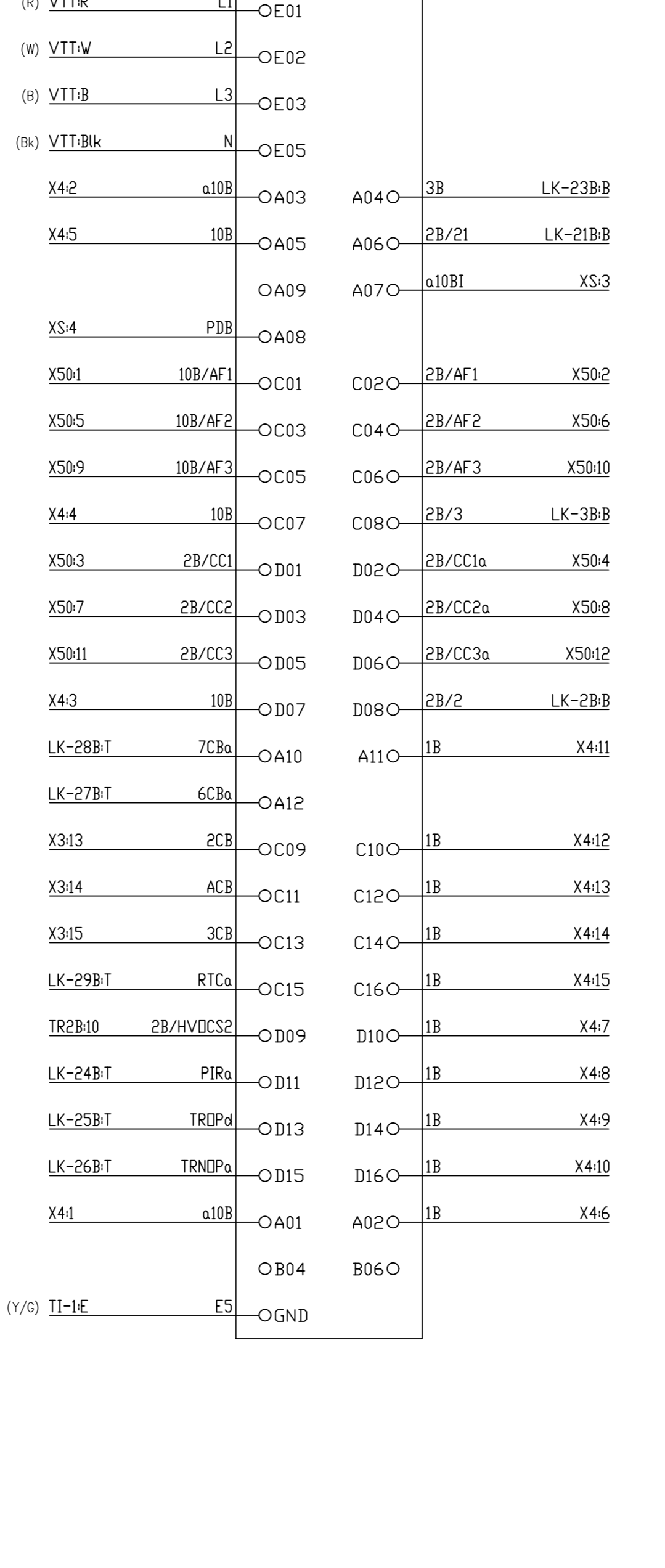
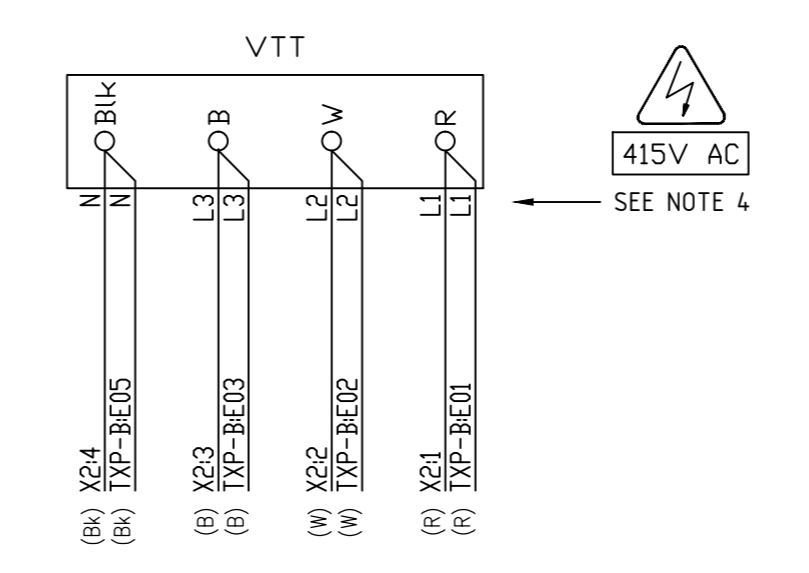
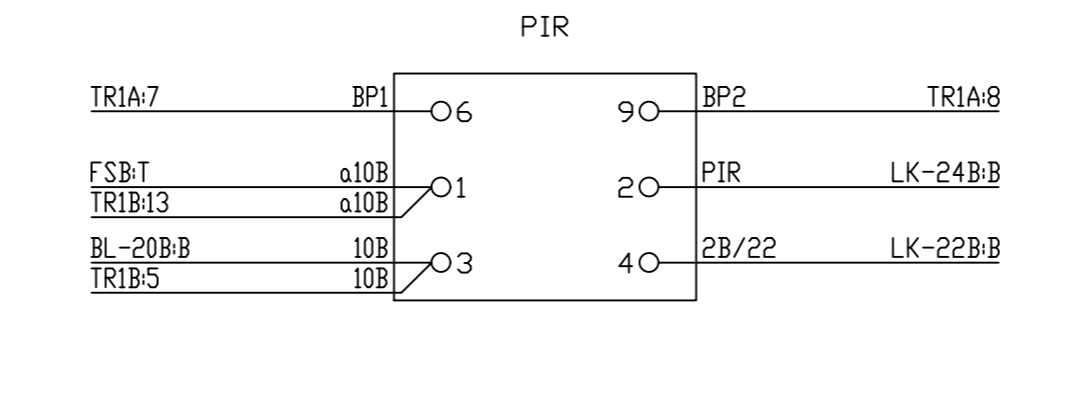
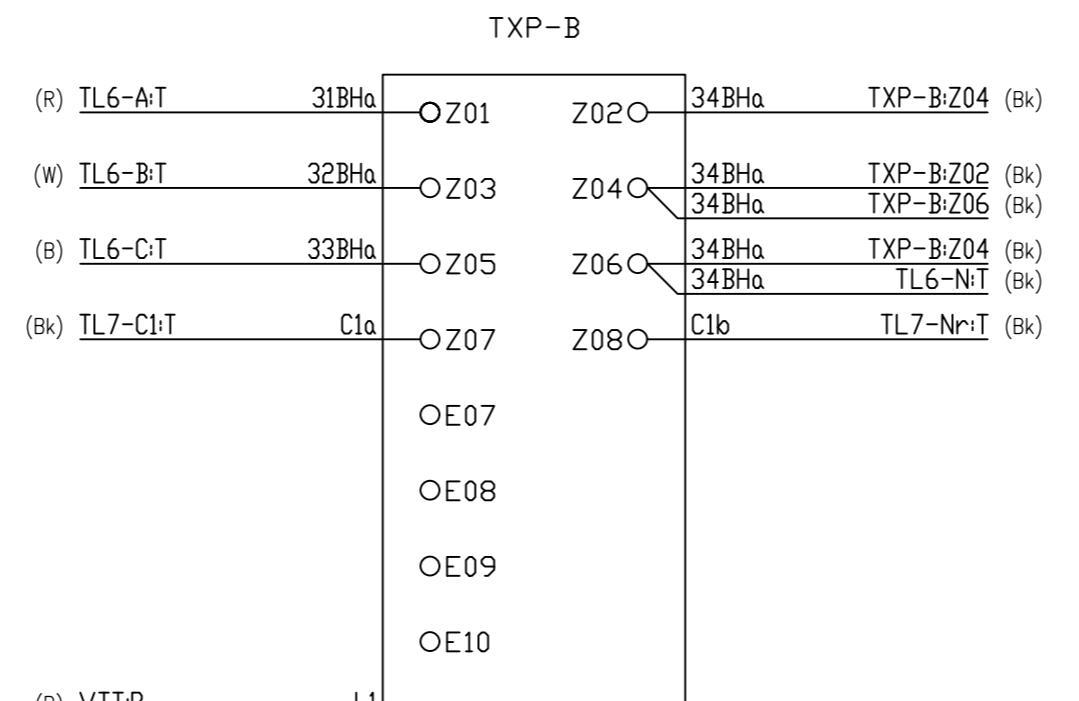
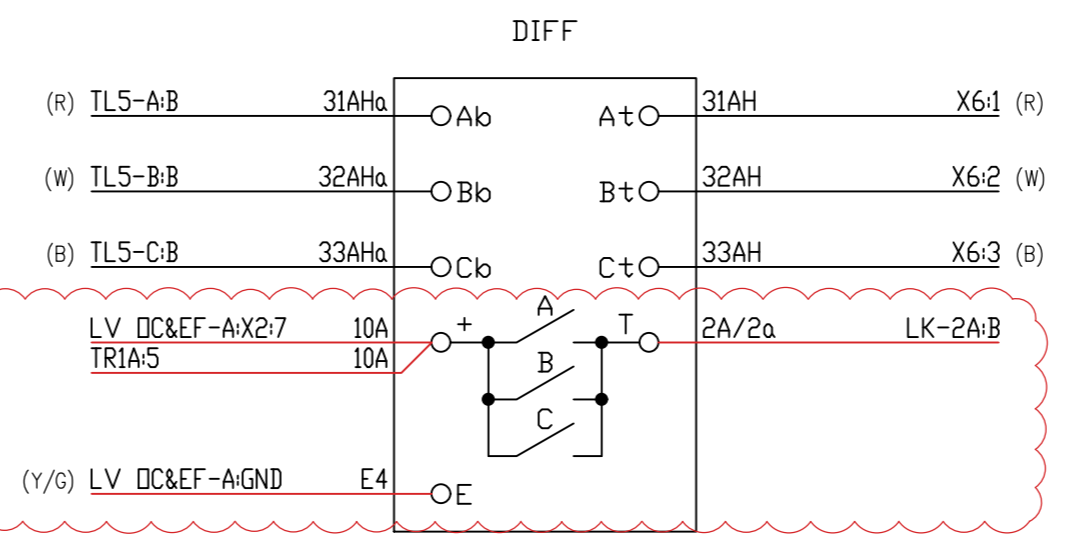
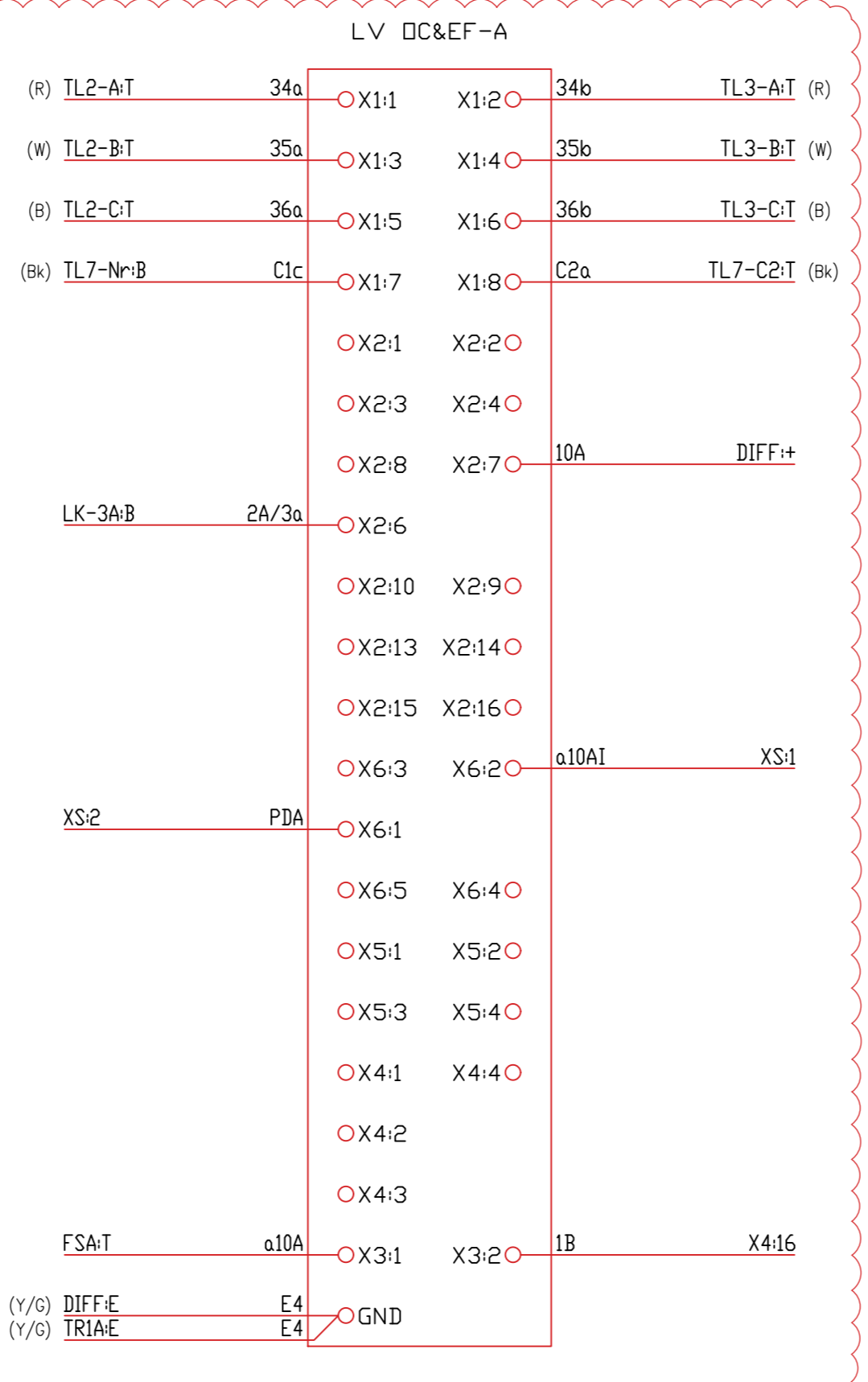
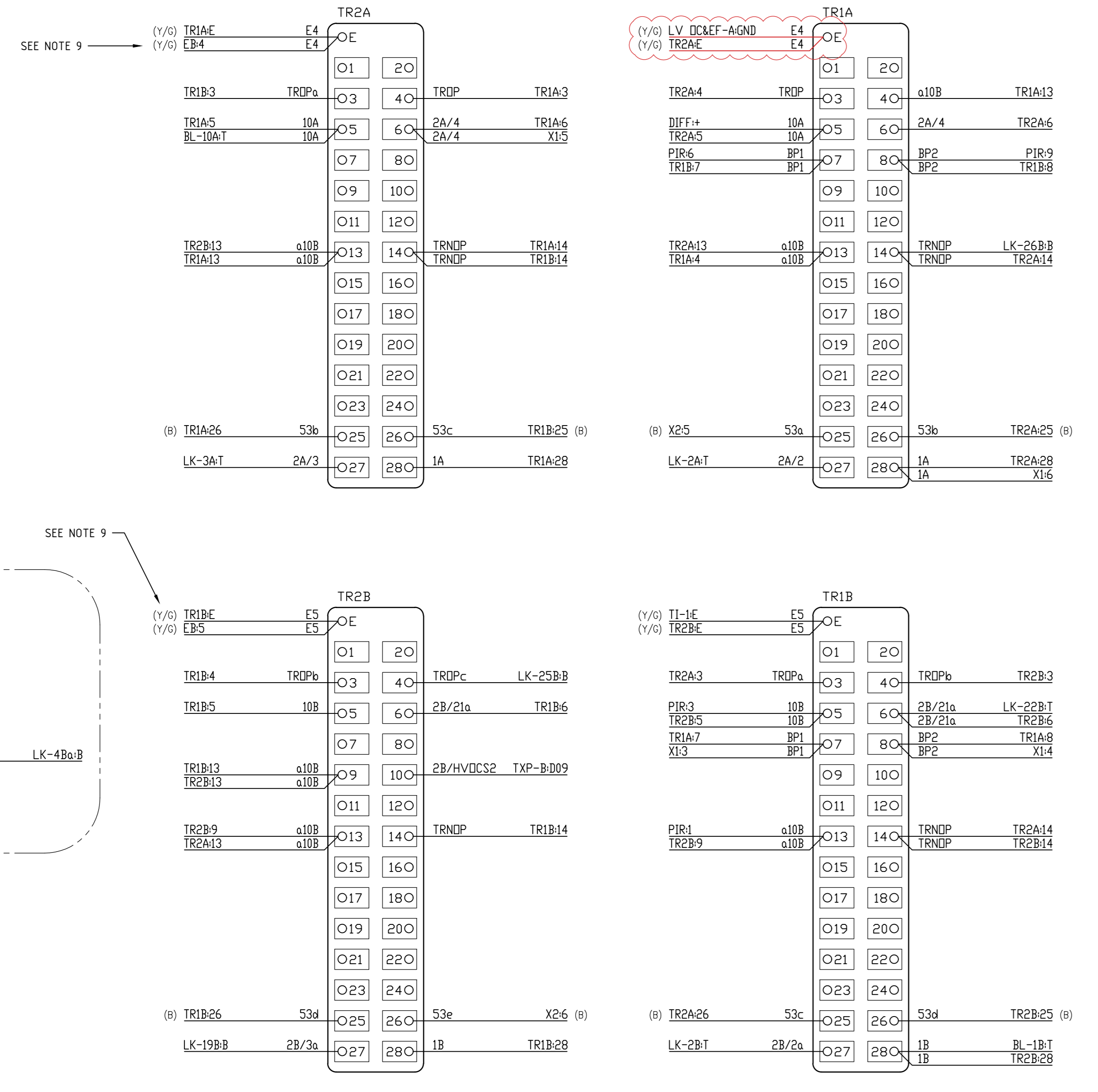

REFERENCE DRAWINGS

Table listing reference drawings with columns for drawing number, title, and DWG No. Includes drawings for LV board, transformer protection, and cable diagrams.

NOTES

- 1. LINKS SHOULD BE MOUNTED SO THAT THE MOVEABLE LINK FALLS OPEN WHEN RELEASED.
2. NUMBERING ON BATTERY AND TEST LINKS REFERS TO LINK IDENTIFICATION AS SHOWN ON THE ASSOCIATED AC & DC SCHEMATICS.
3. ALL PANEL WIRING IS TO BE AS LISTED HERE:
- DC WIRING IS TO BE 7/0.50, 0.6kV GRADE PVC INSULATED COLOURED GREY.
- EARTH WIRING IS TO BE 7/0.67, 0.6kV GRADE PVC INSULATED COLOURED GREEN/YELLOW (Y/G).
- A PHASE CT AND AC WIRING IS TO BE 7/0.67, 0.6kV GRADE PVC INSULATED COLOURED RED (R).
- B PHASE CT AND AC WIRING IS TO BE 7/0.67, 0.6kV GRADE PVC INSULATED COLOURED WHITE (W).
- C PHASE CT AND AC WIRING IS TO BE 7/0.67, 0.6kV GRADE PVC INSULATED COLOURED BLUE (B).
- EARTH CT AND NEUTRAL AC WIRING IS TO BE 7/0.67, 0.6kV GRADE PVC INSULATED COLOURED BLACK (BK).

Table with columns: TAGNAME, MFG, CATNO, DESC, REF. DWG. Lists components like relays, fuses, and test sockets with their manufacturer and part numbers.

TRANSFORMER PROTECTION PANEL (FRONT VIEW)

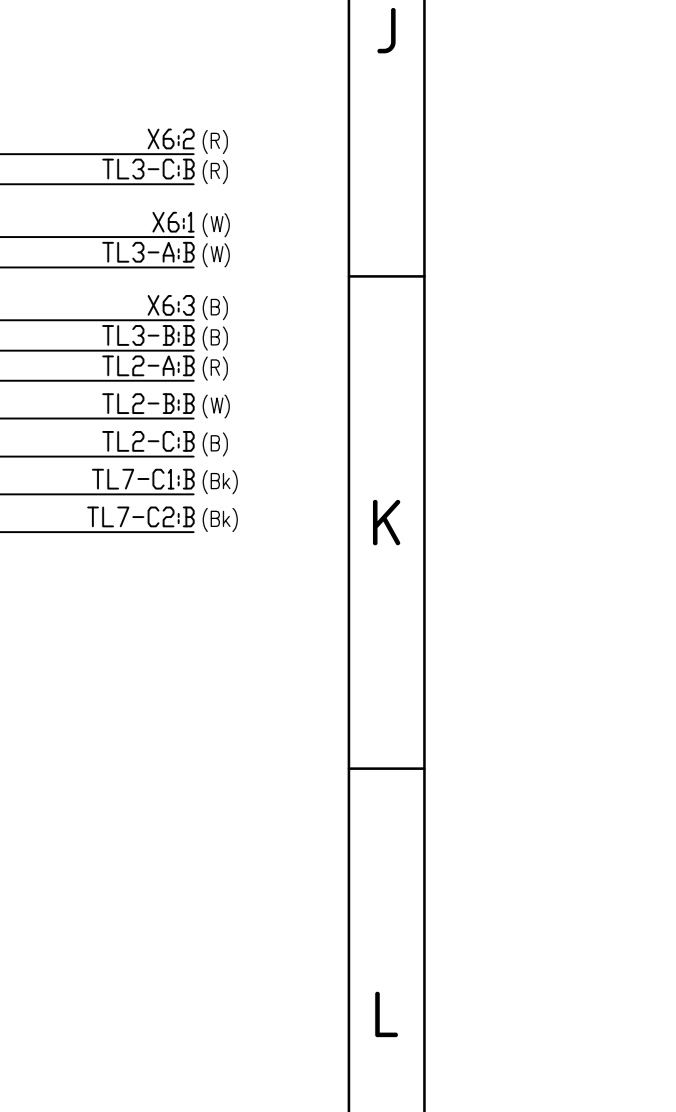
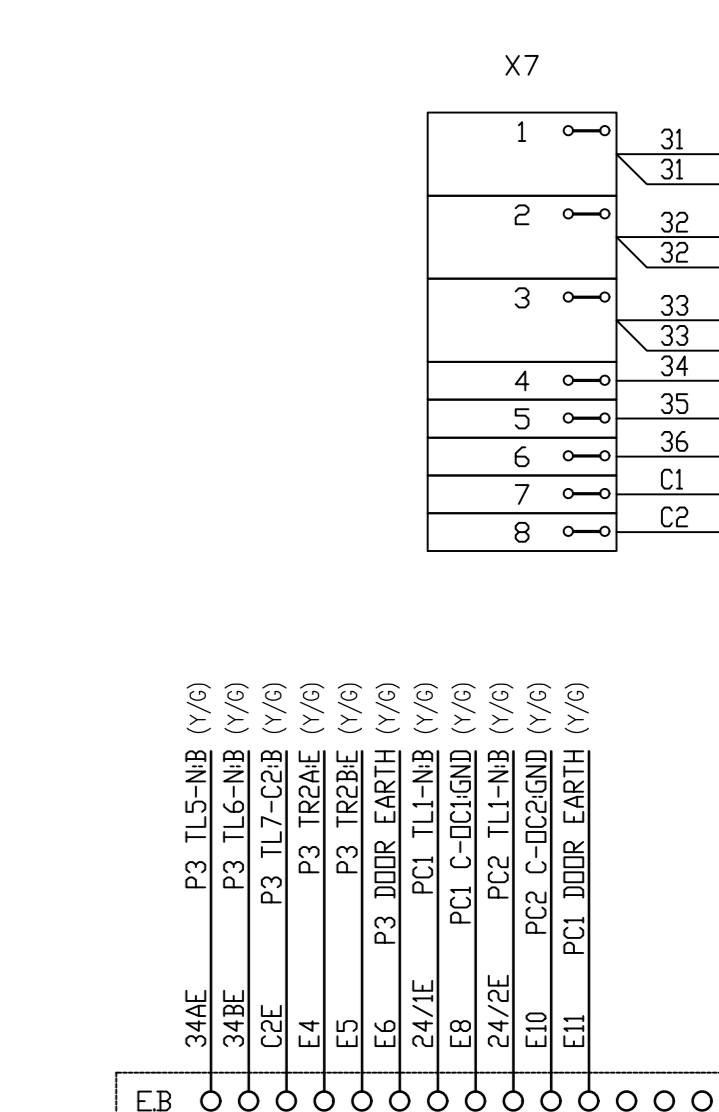
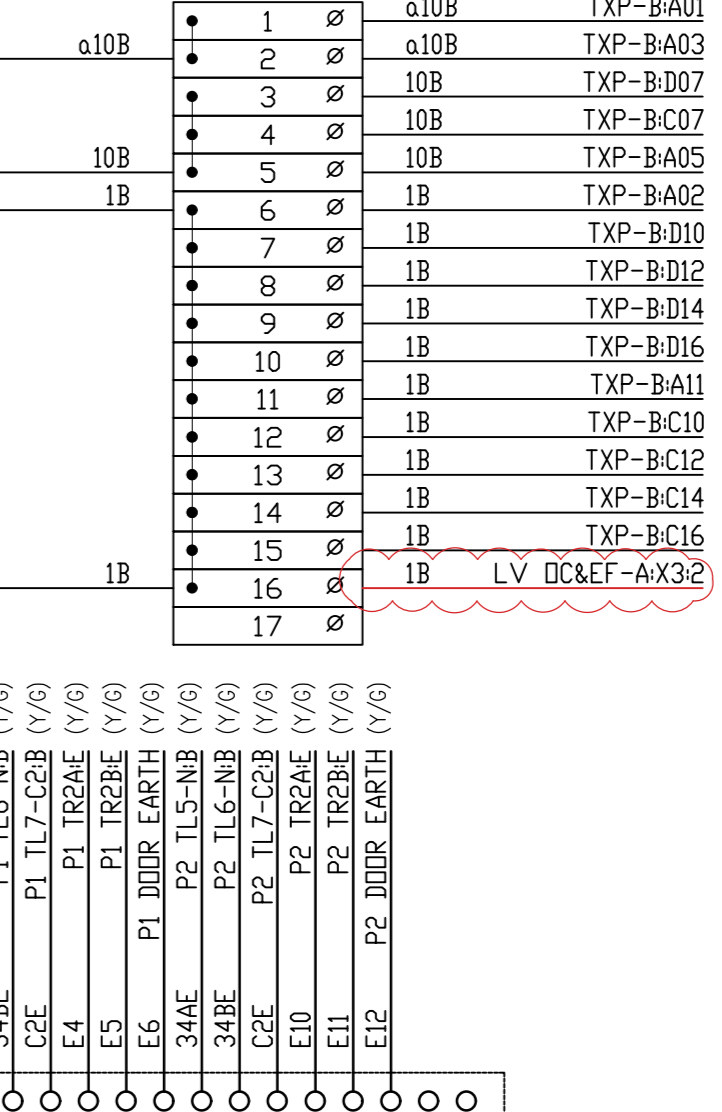
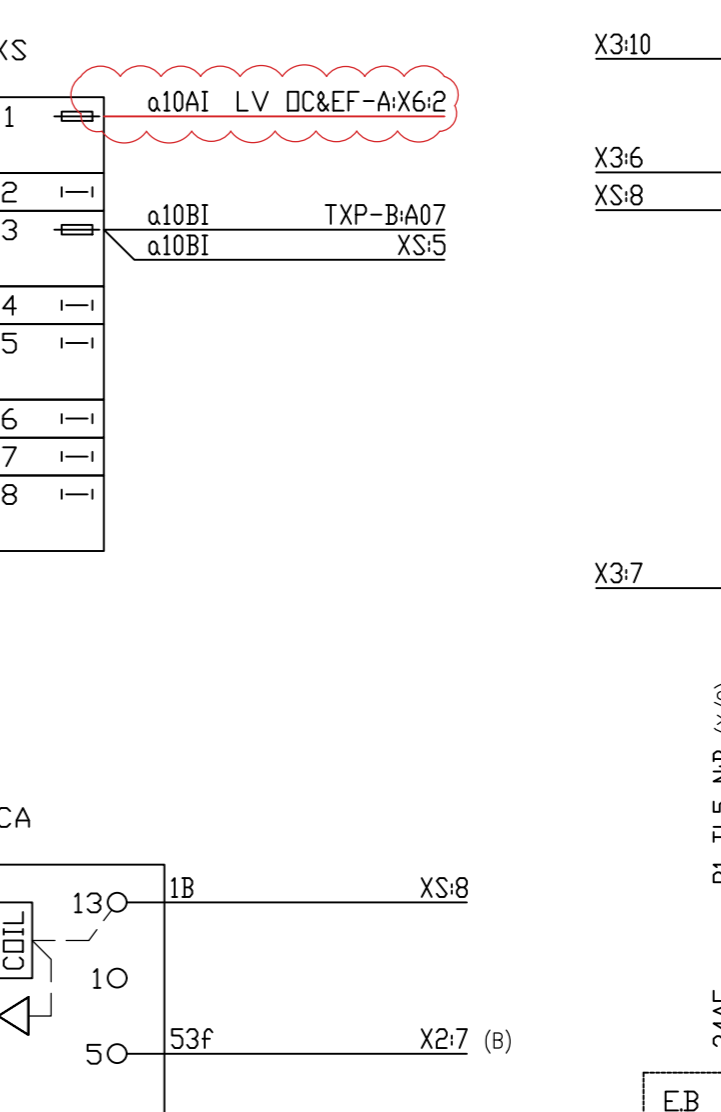
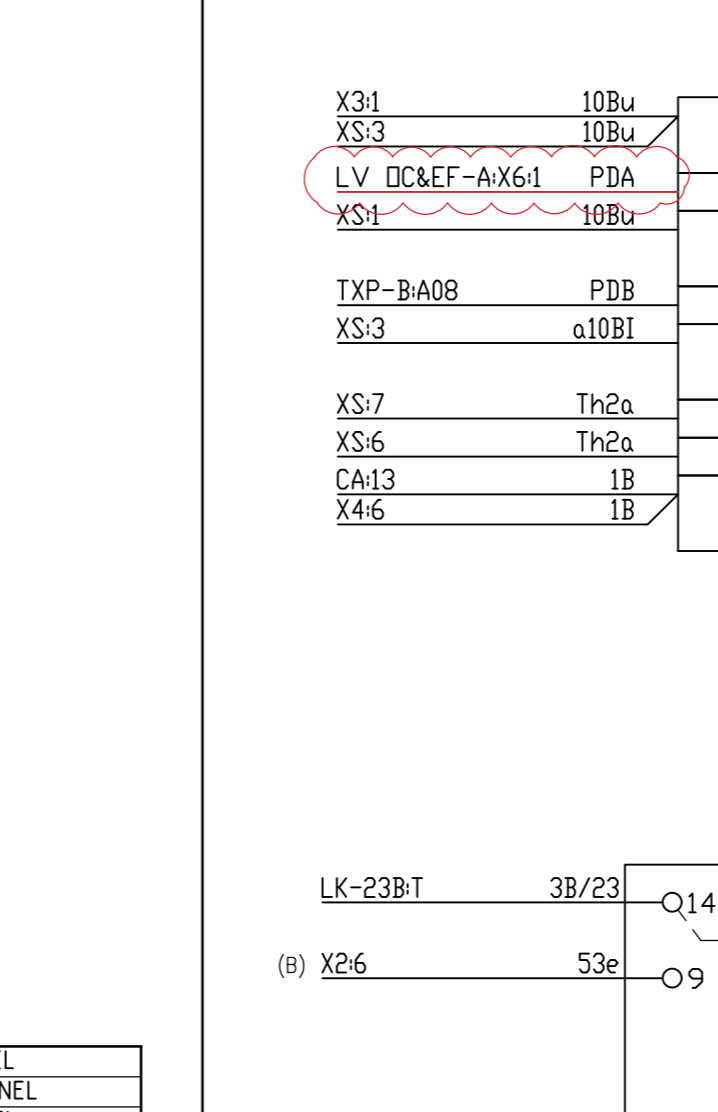
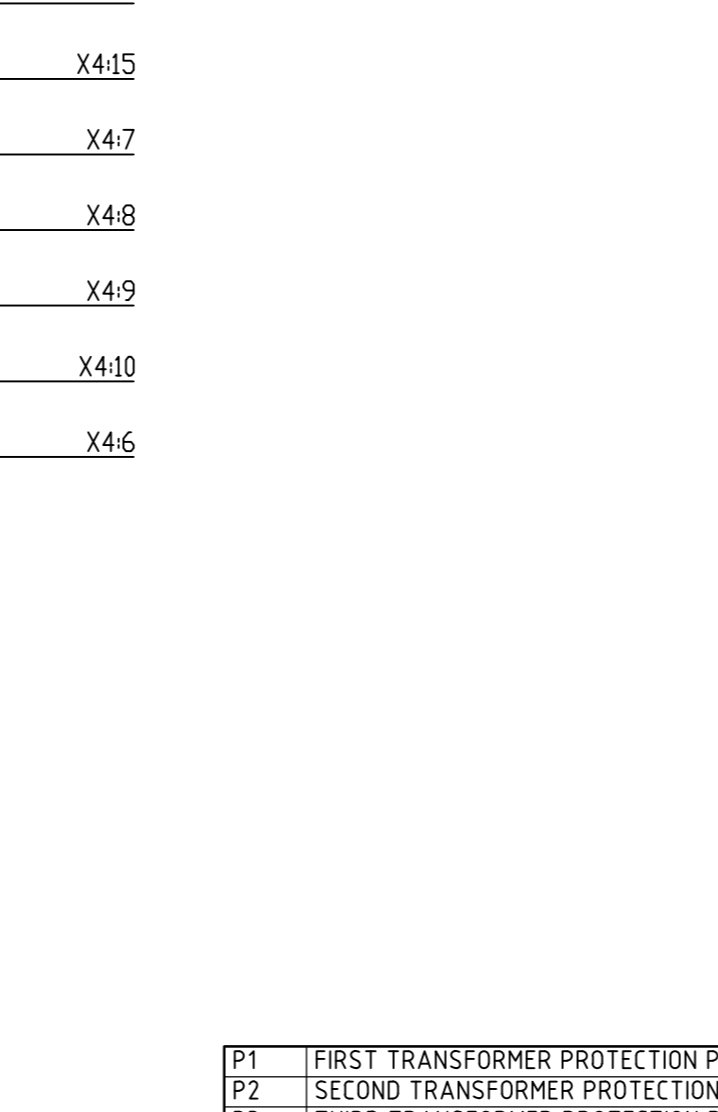
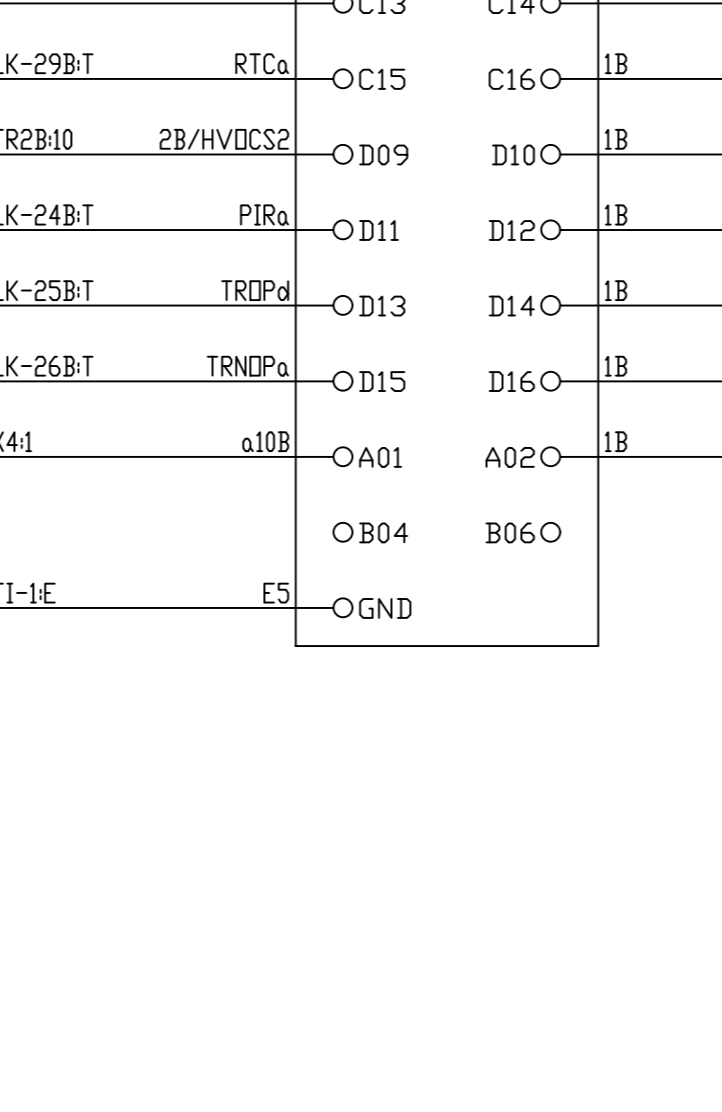
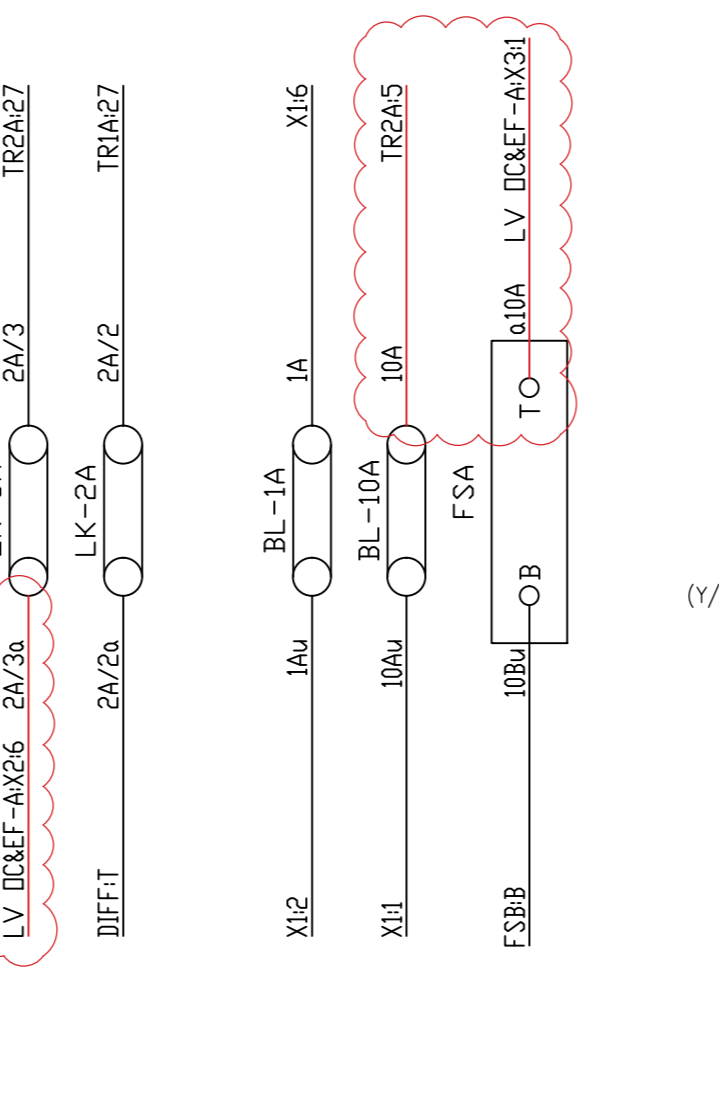
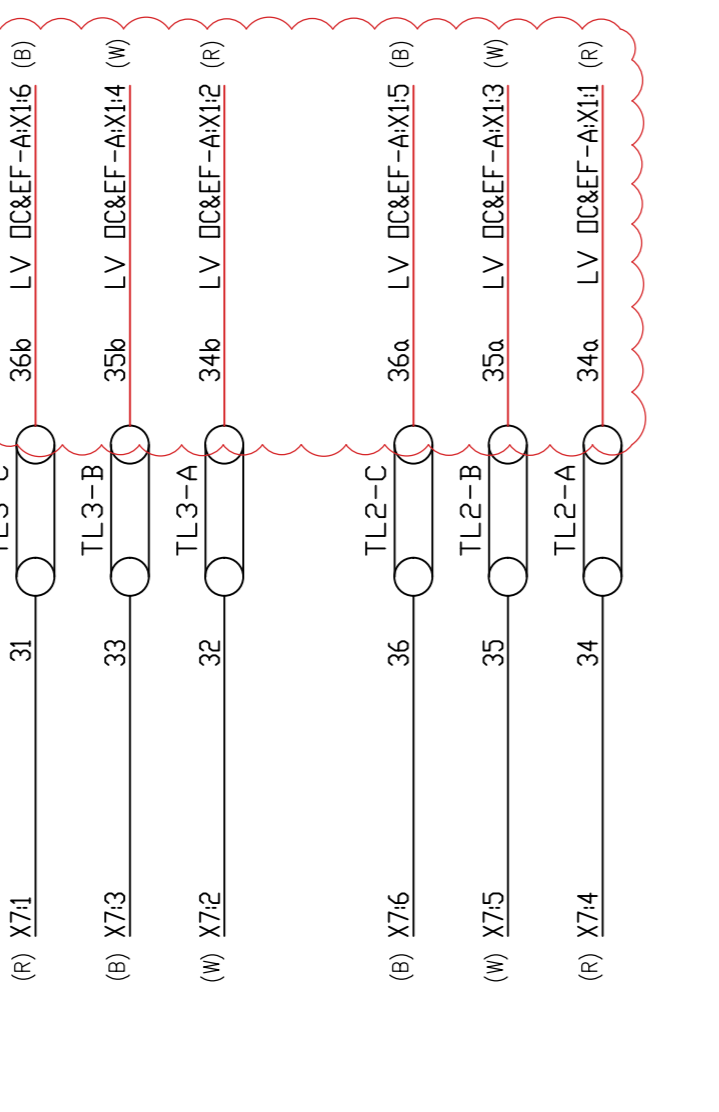
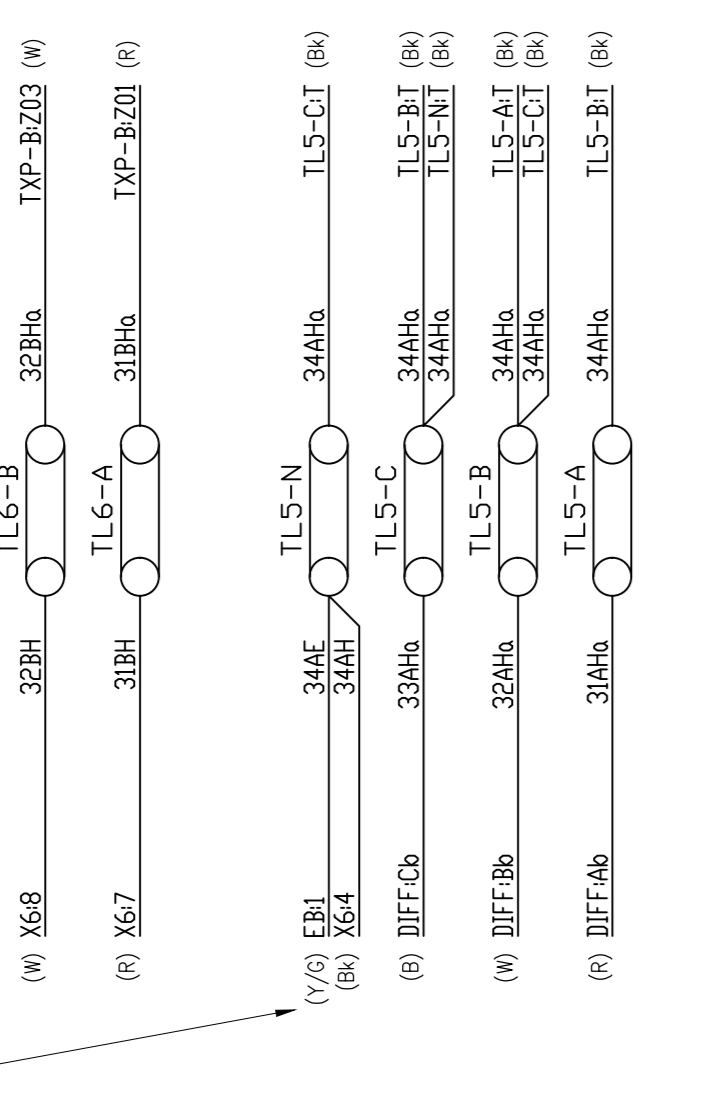
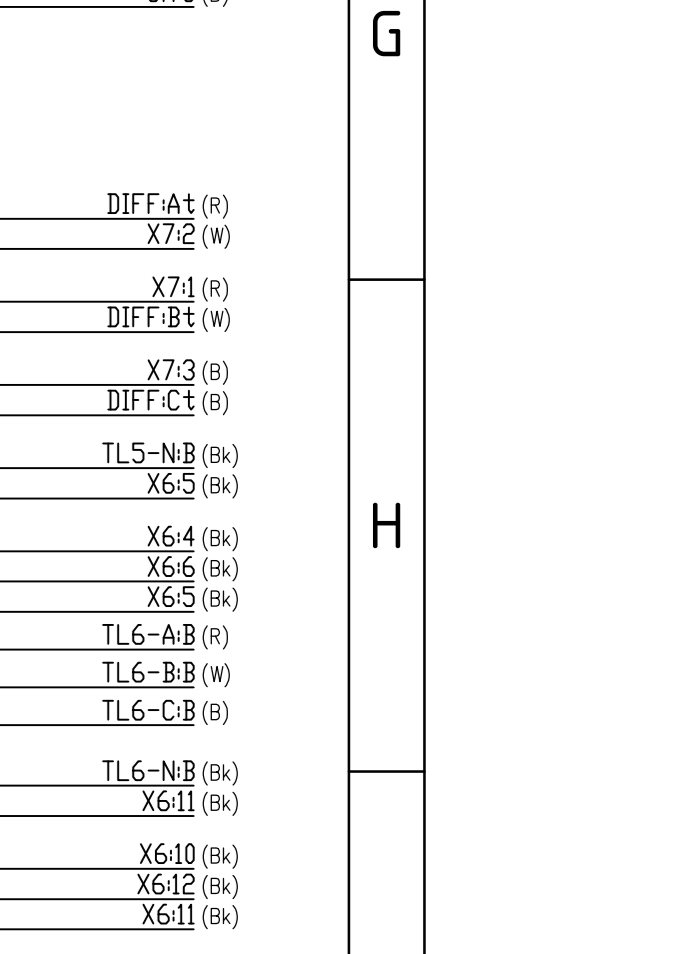
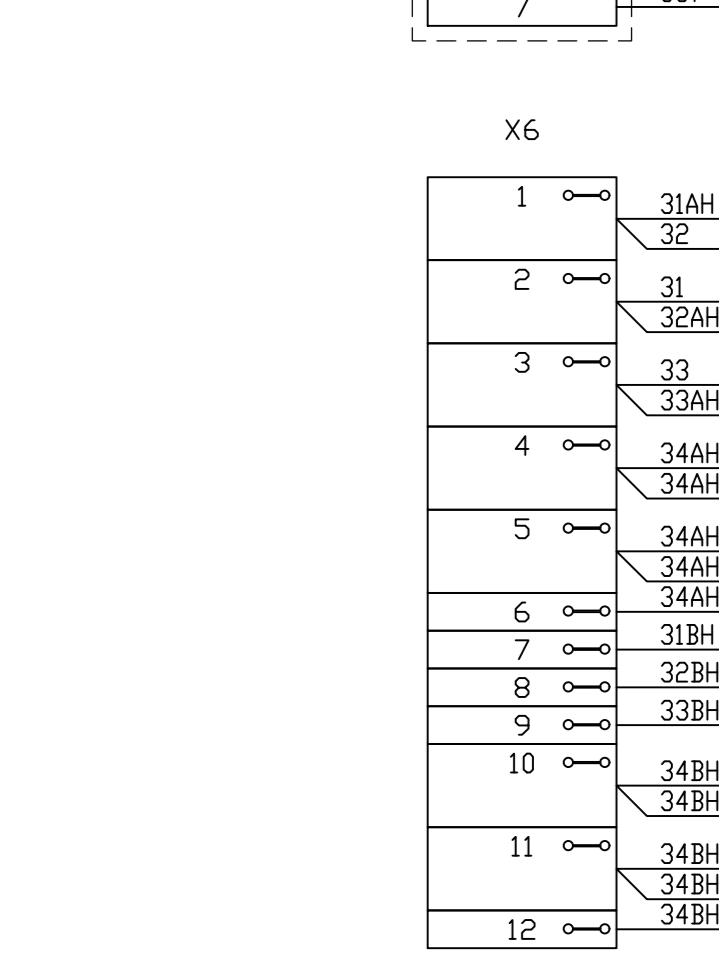
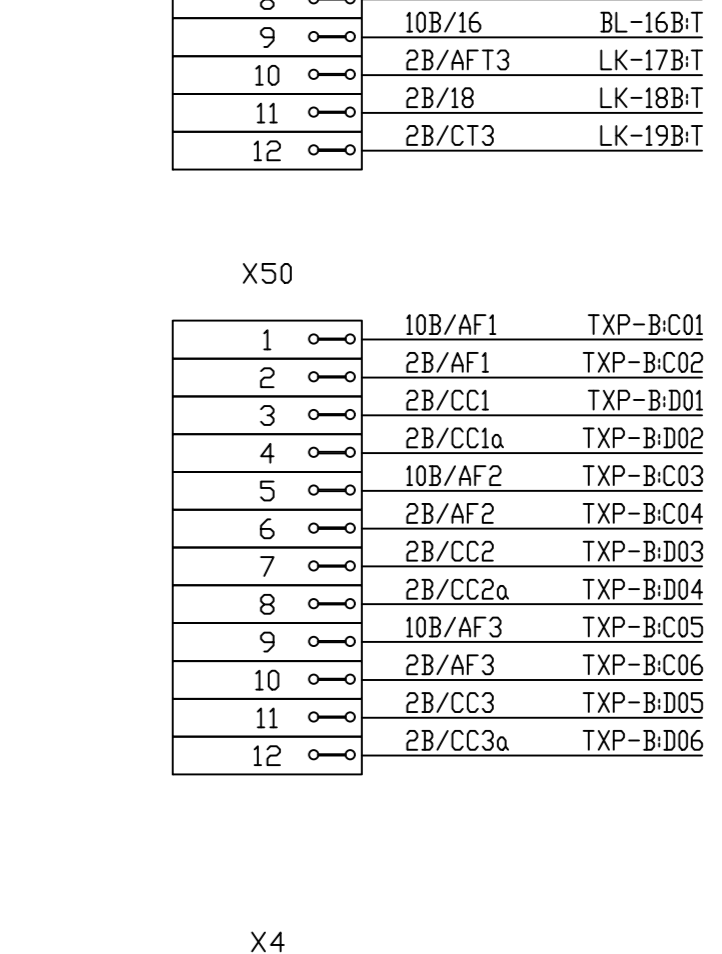
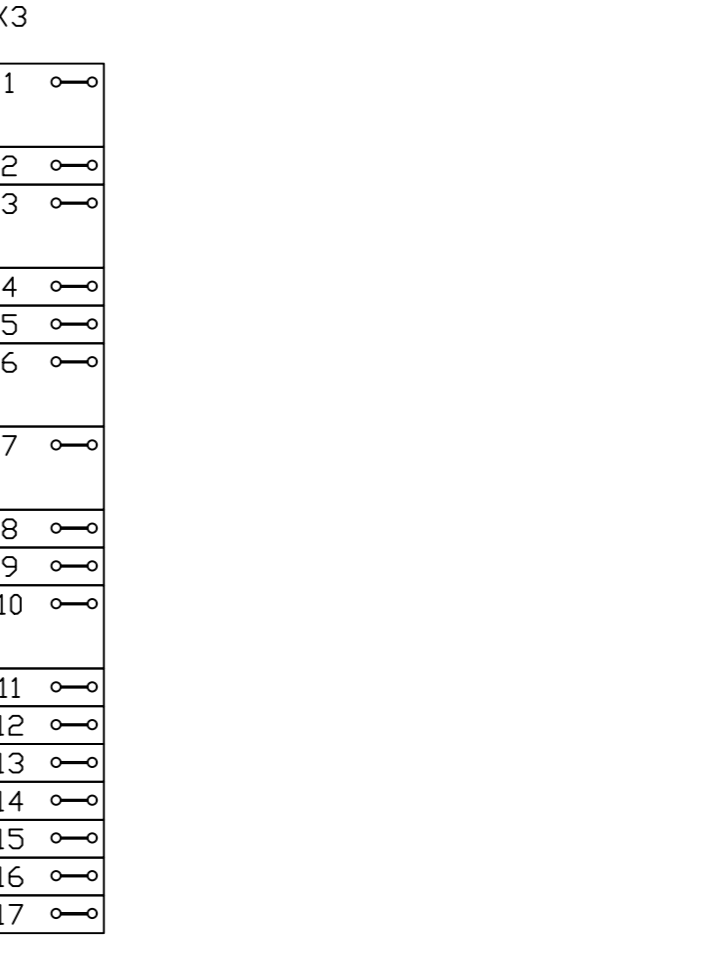
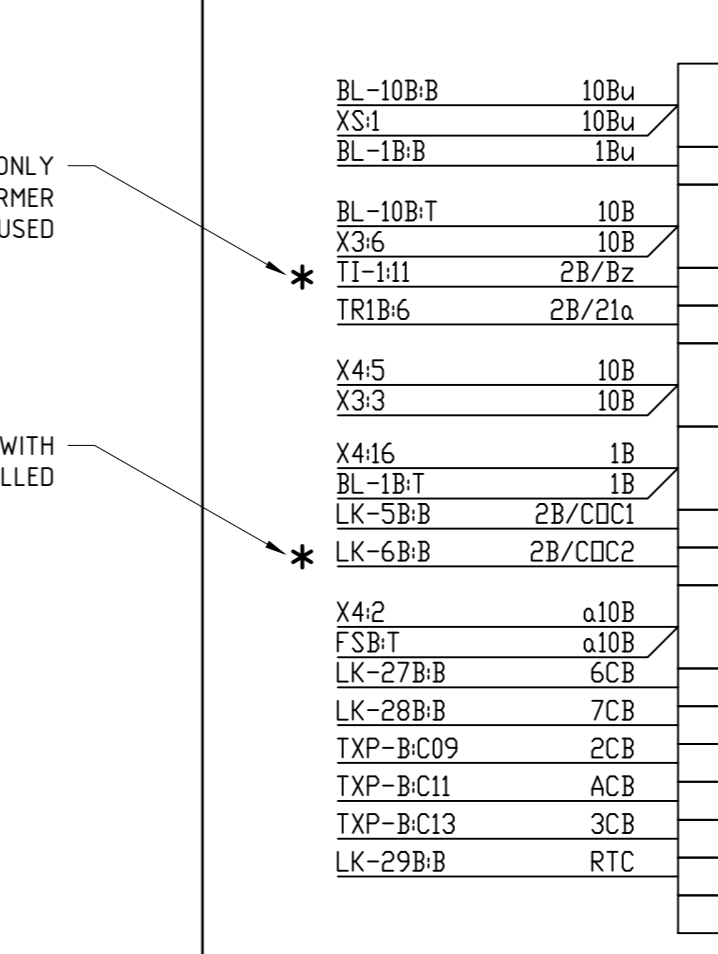
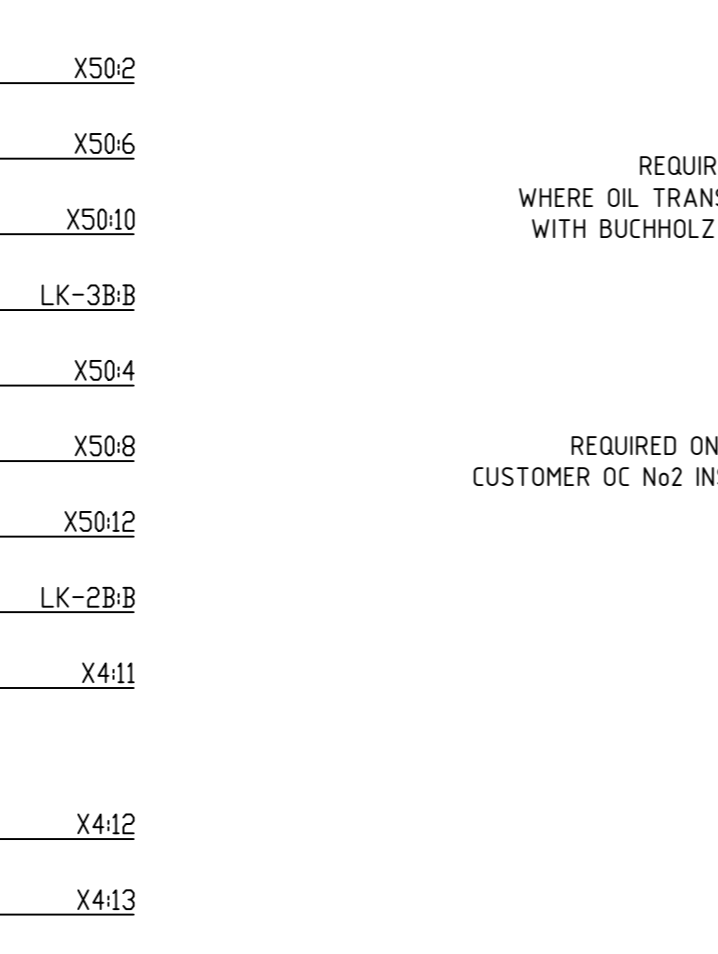
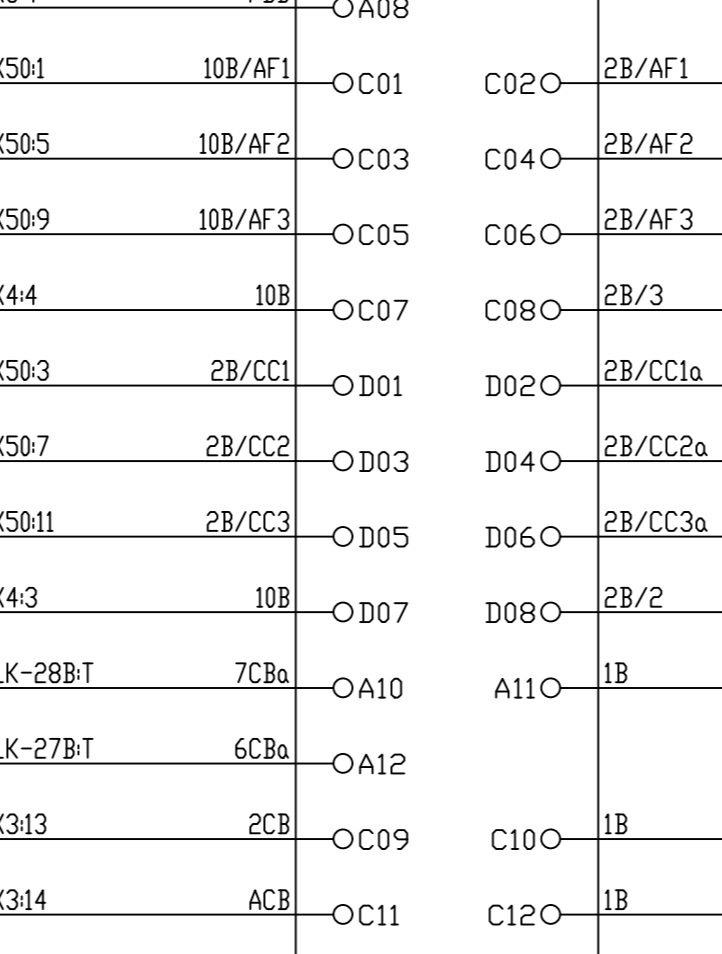
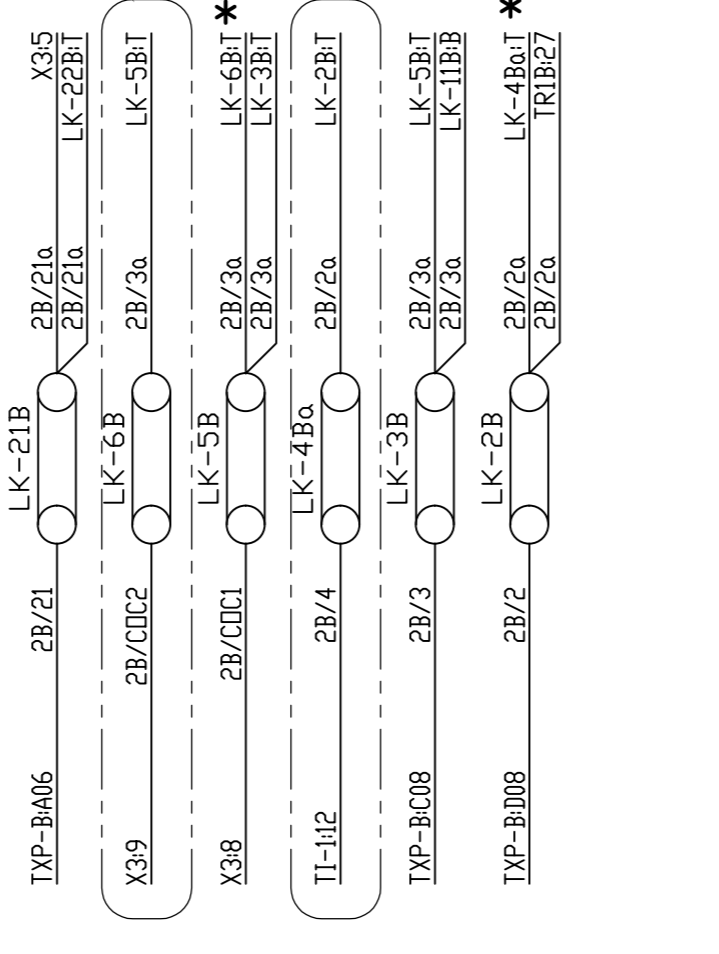
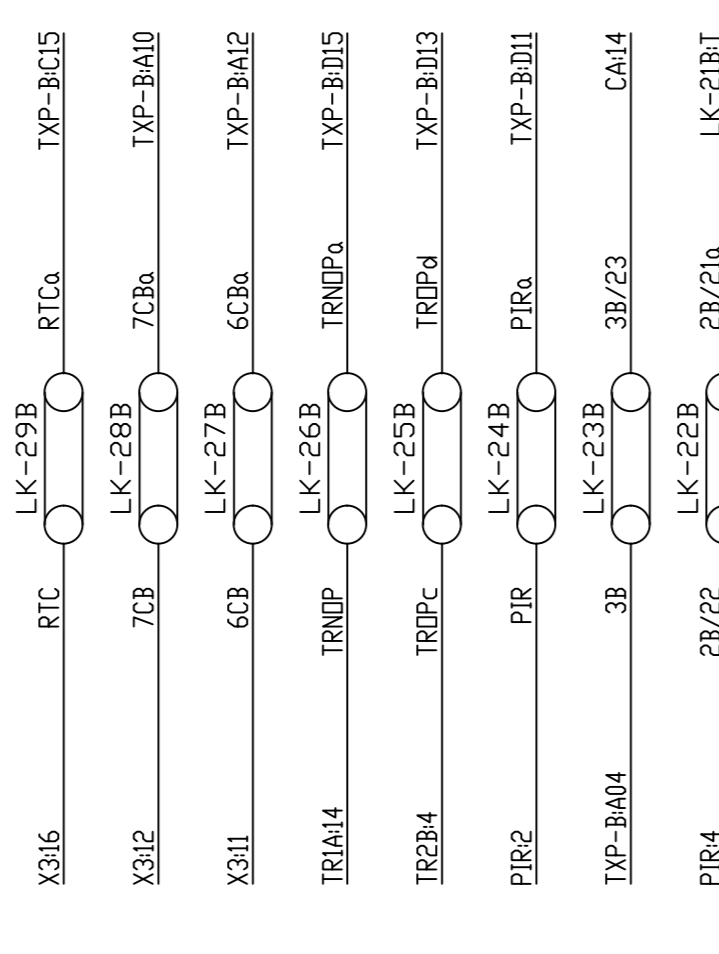
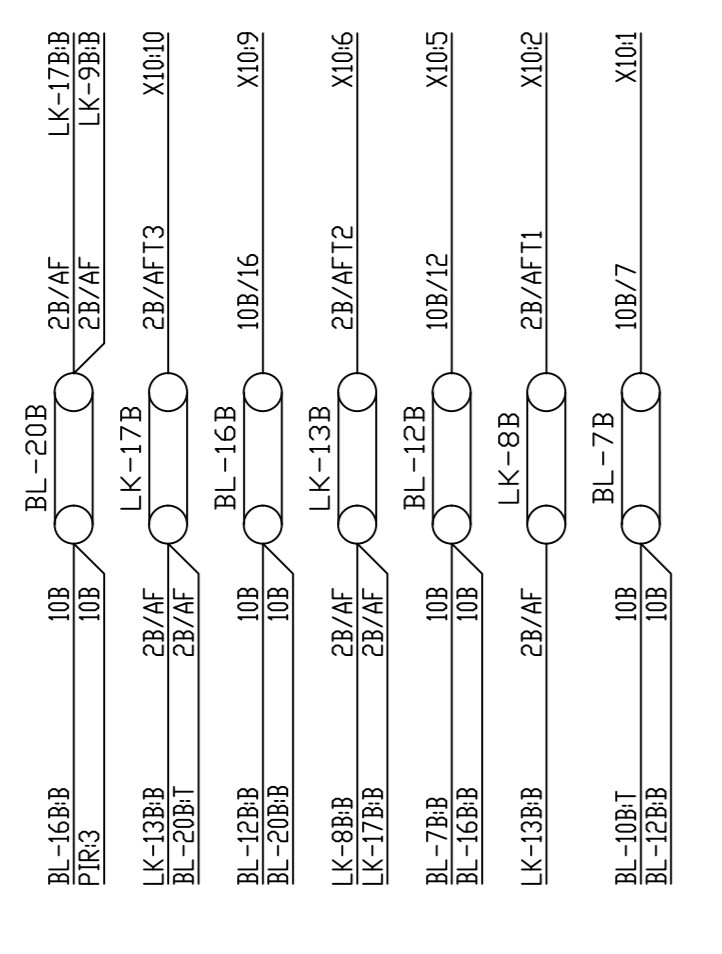
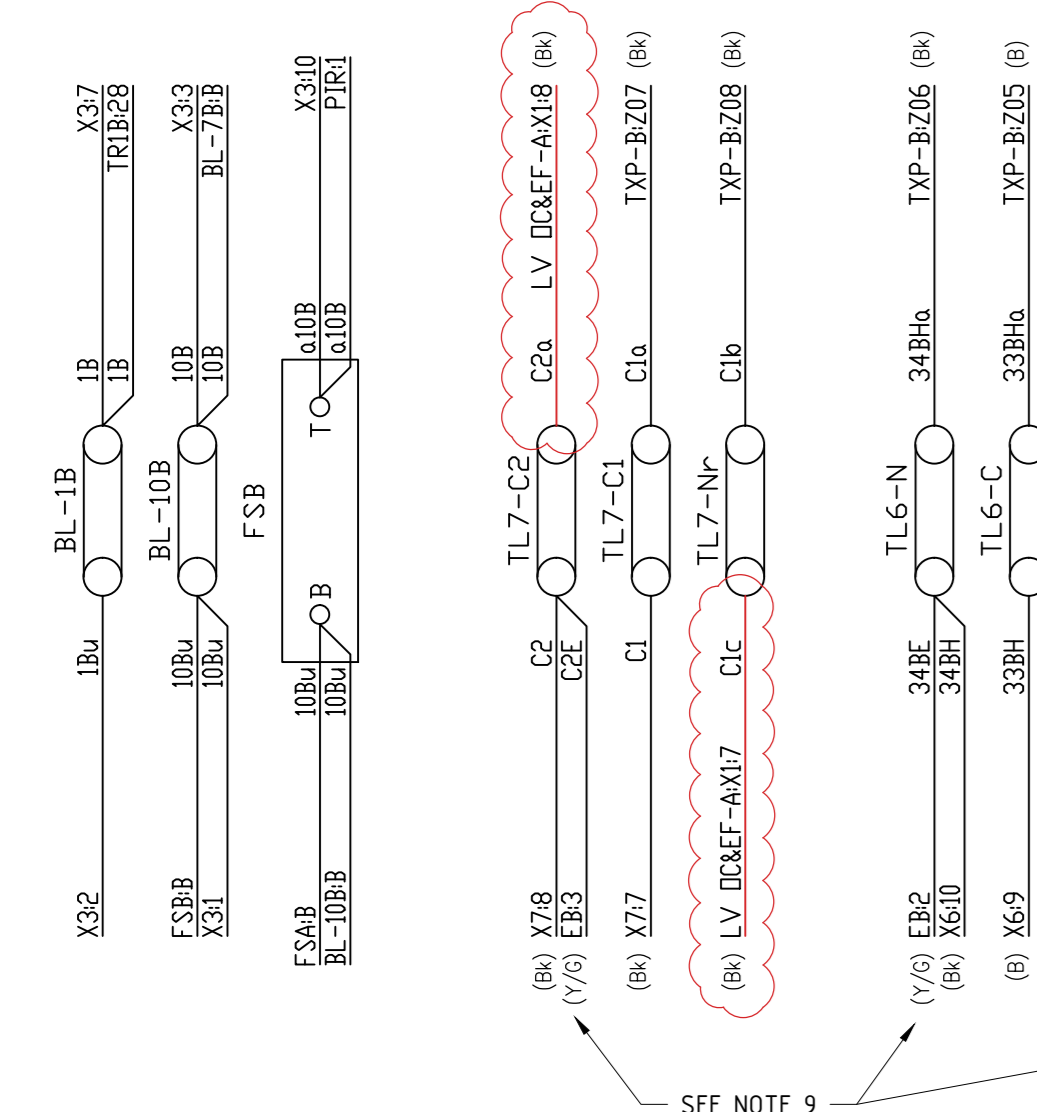
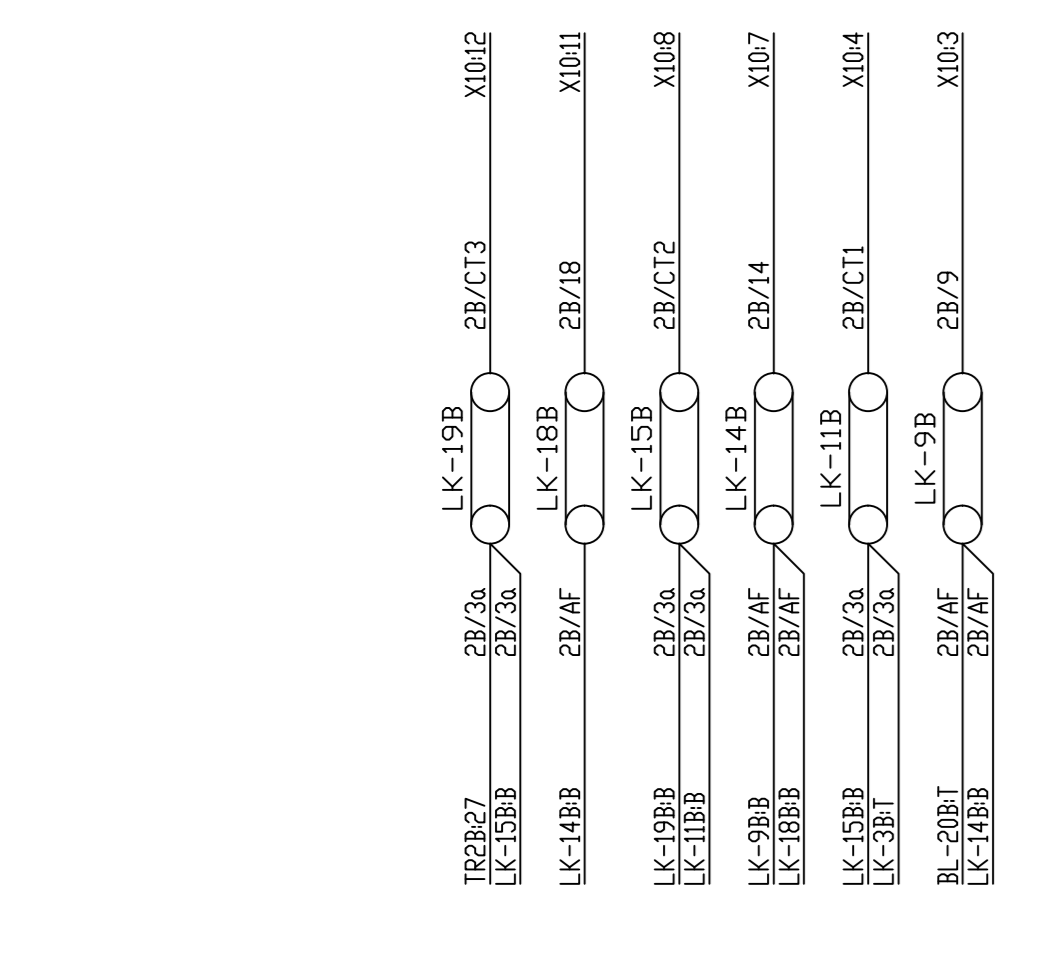
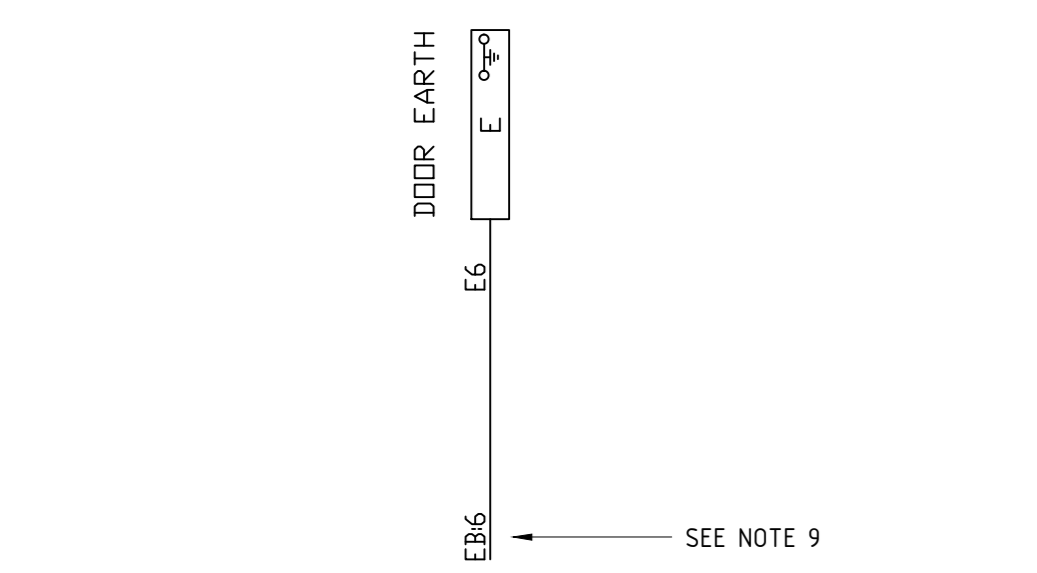
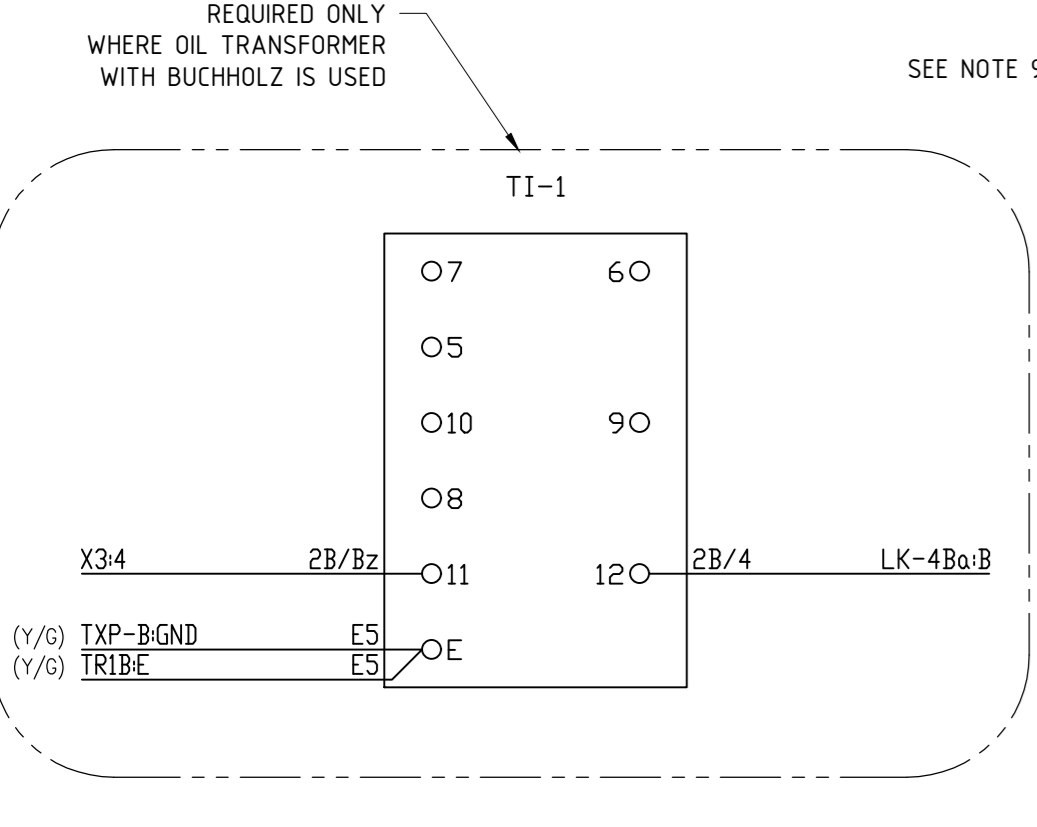
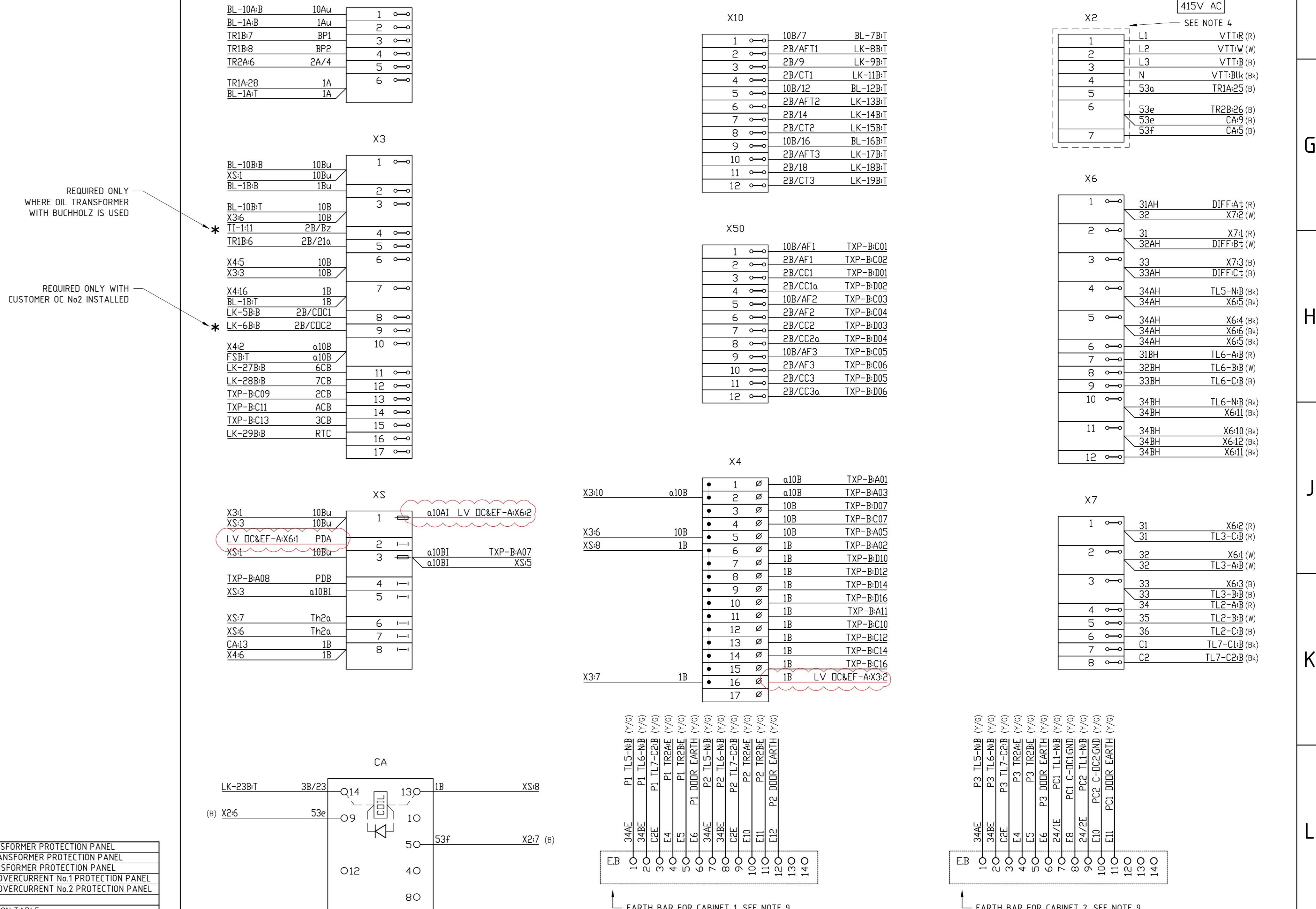

Table with columns: AMD, DATE, AMENDED WIRE FERRULE ON TERMINAL X34 WAS 2B/4, DESCRIPTION, DRAWN BY, DESIGNED BY, CHECKED BY, APPROVED BY. Lists amendments to the drawing.

FOR ARRANGEMENT WITH DRY TYPE TRANSFORMERS SEE 227383 Sh1

Ausgrid logo and address: 24 Campbell Street, SYDNEY NSW 2000, P. 9272 3805.

Table with columns: SCALE, DESIGNED, DRAWN, CHECKED, APPROVED, DATE, TRIM REF, PROJECT NUMBER. Lists project details.

CITY DISTRIBUTION SUBSTATIONS WITH E TYPE LV BOARD & OIL TYPE TX & OPTICAL ARC FLASH DETECTION TRANSFORMER PROTECTION PANEL WIRING DIAGRAM. DRAWING No 227383 SHEET 2 AMD 4 SIZE A0